

511620
PROCRAFT PETROL
PRESSURE CLEANER WITH
13HP ENGINE 4000PSI

TOOLEX[®]
Industrial

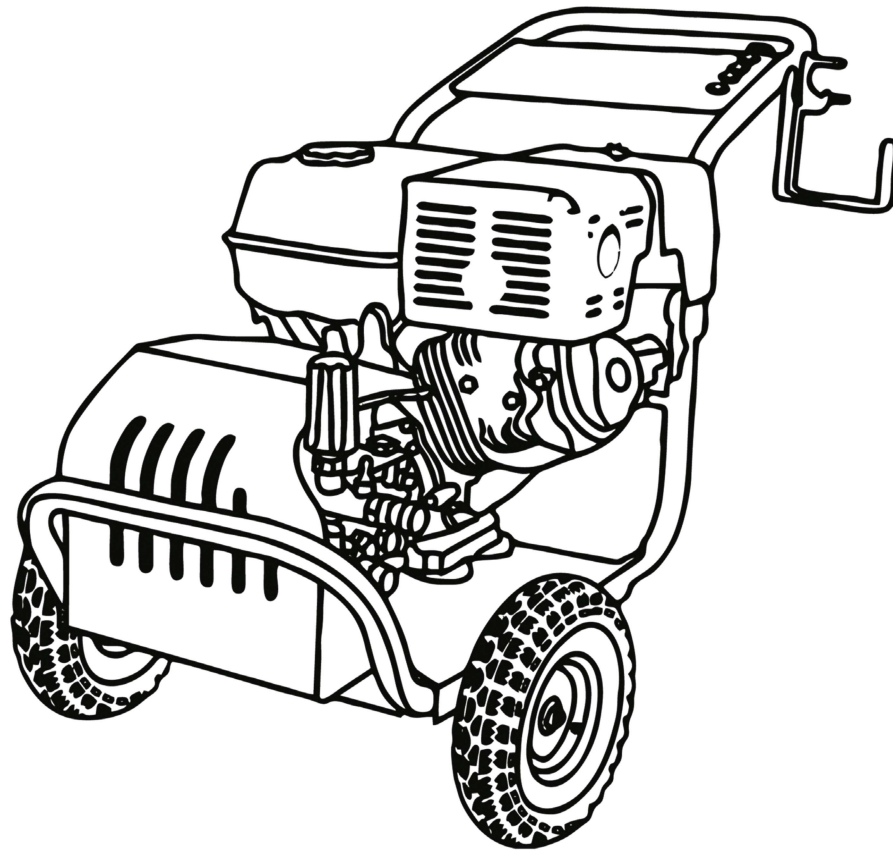

CONSUMER SERVICE CENTRE
PO BOX 1012
HAMILTON NSW 2303 AUSTRALIA
Assembled in Australia

INSTRUCTION MANUAL

TABLE OF CONTENTS

IMPORTANT SAFETY INSTRUCTIONS	1-4
CARTON CONTENTS.....	5
SPECIFICATIONS	5
ASSEMBLY INSTRUCTIONS.....	6
OPERATING INSTRUCTIONS	7-12
MAINTENANCE	13-14
STORAGE.....	15
PUMP DIAGRAM.....	16-17
TROUBLE SHOOTING GUIDE.....	18-19
QUICK FACTS.....	20

SAFETY GUIDELINES /DEFINITIONS

This manual contains information that is important for you to know and understand. This information relates to protecting YOUR SAFETY and PREVENTING EQUIPMENT PROBLEMS. Please read the manual and attend to these sections.

DANGER indicates an imminent hazardous situation which, if not avoided, will result in death or serious injury.



WARNING indicates a potentially hazardous situation which, if not avoided, could result in death or serious injury.

CAUTION indicates a potentially hazardous situation which, if not avoided, may result in minor or moderate injury.

NOTE used without the safety alert symbol indicating potentially hazardous situation which, if not avoid, may result in property damage.

IMPORTANT SAFETY INSTRUCTIONS

!WARNING Read operation manual. Do not operate equipment until you have read operation manual for safety, assembly, operation, and maintenance instructions.

Hazard	
! DANGER RISK OF EXPLOSION OR FIRE  	
WHAT CAN HAPPEN	HOW TO PREVENT IT
<ul style="list-style-type: none"> ● Spilled petrol and it's vapors can become ignited from cigarette sparks, electrical arcing, exhaust gases, and hot engine components such as the silencer. 	<ul style="list-style-type: none"> ● Shut off engine and allow it to cool before adding fuel to the tank. ● Use care in filling tank to avoid spilling fuel. ● Move washer pump away from fueling area before starting engine.
<ul style="list-style-type: none"> ● Heat will expand fuel in the tank which could result in spillage and possible fire explosion. 	<ul style="list-style-type: none"> ● Keep maximum fuel level 10mm below top of tank to allow for expansion.
<ul style="list-style-type: none"> ● Operating the washer pump in an explosive environment could result in a fire. 	<ul style="list-style-type: none"> ● Operate and fuel equipment in well ventilated zones free from obstructions. Equip zone with fire extinguisher suitable for gasoline fires.
<ul style="list-style-type: none"> ● Materials placed against or near the washer pump can interfere with its proper ventilation causing overheating and possible ignition of the materials. 	<ul style="list-style-type: none"> ● Never operate washer pump in an area containing dry brush or weeds.
<ul style="list-style-type: none"> ● Silencer exhaust heat can damage painted surfaces , melt any material sensitive to heat (such as siding, plastic, rubber, or vinyl) and damage live plants. 	<ul style="list-style-type: none"> ● Always keep washer pump a minimum of five feet away from surfaces (such as houses, automobiles, or live plants) that could be damaged from muffler exhaust heat.
<ul style="list-style-type: none"> ● Improperly stored fuel could lead to accidental ignition. Improperly secured fuel could get into the hands of children or other unqualified persons. 	<ul style="list-style-type: none"> ● Store fuel in an approved container in a secure location away from work area.
<ul style="list-style-type: none"> ● Use of acids, toxic or corrosive chemicals, poisons, insecticides, or any kind of flammable solvent with this product could result in serious injury or death. 	<ul style="list-style-type: none"> ● Do not spray flammable liquids.

Hazard	
! DANGER RISK TO BREATHING 	
WHAT CAN HAPPEN	HOW TO PREVENT IT
<ul style="list-style-type: none"> Breathing exhaust fumes will cause serious injury even death! Some cleaning fluids contain substances that could cause injury to skin, eyes, or lungs. 	<ul style="list-style-type: none"> Operate washer pump in a well ventilated area. Avoid enclosed areas such as garages, basements, etc. Never operate unit in a location occupied by humans or animals. Use only cleaning fluids specifically recommended for washer pump. Follow manufactures recommendations. do not use chlorine bleach or any other corrosive compound.

Hazard	
! DANGER RISK OF INJURY OR PROPERTY DAMAGE WHEN TRANSPORTING OR STORING 	
WHAT CAN HAPPEN	HOW TO PREVENT IT
<ul style="list-style-type: none"> Fuel or oil can leak or spill and could result in fire or breathing hazard, serious injury or death. Fuel or oil leaks will damage carpet, paint or other surfaces in vehicles or trailers. 	<ul style="list-style-type: none"> If washer pump is equipped with a fuel shut-off valve, turn the valve to the off position before transportation to avoid fuel leaks. If washer pump is not equipped with a fuel shut-off valve, drain the fuel from tank before transportation, only transport fuel in an approved container, always place washer pump on a protective mat when transporting to protect against damage to vehicle from leaks. Remove washer pump from vehicle immediately upon arrival at your destination.

Hazard	
! DANGER RISK OF HOT SURFACES 	
WHAT CAN HAPPEN	HOW TO PREVENT IT
<ul style="list-style-type: none"> Contact with hot surfaces, such as engines exhaust components, could result in serious burn. 	<ul style="list-style-type: none"> During operation, touch only the control surfaces of the washer pump. Keep children away from the washer pump at all times. They are too young to recognize the hazards of this product.



Hazard	
<div style="display: flex; justify-content: space-between; align-items: center;"> ! DANGER RISK OF FLUID INJECTION  </div>	
WHAT CAN HAPPEN	HOW TO PREVENT IT
<ul style="list-style-type: none"> Your washer operates at fluid pressures and velocities high enough to penetrate human and animal flesh, which could result in amputation or other serious injury. Leaks caused by loose fittings or damaged hoses can result in injection injuries. DO NOT TREAT FLUID INJECTION AS A SIMPLE CUT! See a physician immediately! Injuries can result if system pressure is not reduced before attempting maintenance or disassembly. 	<ul style="list-style-type: none"> Never place hands in front of nozzle. Direct spray away from self or others. Make sure hose and fittings are tightened and in good condition. Never hold onto the hose or fittings during operation. Do not allow hose to contact muffler. Never attach or remove lance or hose fittings while system is pressurized. To relieve system pressure, shut off engine, turn off water supply, and pull gun trigger until water stops flowing. Use only hose and accessories rated for pressure higher than your washer pump's PSI.

Hazard	
<div style="display: flex; justify-content: space-between; align-items: center;"> ! DANGER RISK OF INJURY FROM SPRAY  </div>	
WHAT CAN HAPPEN	HOW TO PREVENT IT
<ul style="list-style-type: none"> High velocity fluid spray can cause objects to break, propelling particles at high speed. Light or unsecured objects can become hazardous projectiles. 	<ul style="list-style-type: none"> Always wear approved safety glasses. Wear protective clothing to protect against accidental spraying. Never point lance at people or animals. Always secure trigger lock when lance is not in service to prevent accidental operation. Never permanently secure trigger in open position.

Hazard	
<div style="display: flex; justify-content: space-between; align-items: center;"> ! DANGER RISK OF CHEMICAL BURN  </div>	
WHAT CAN HAPPEN	HOW TO PREVENT IT
<ul style="list-style-type: none"> Use of acids toxic or corrosive chemicals, poisons, insecticides, or any kind of flammable solvent with this product could result in serious injury or death. 	<ul style="list-style-type: none"> Do not use acids, petrol, kerosene, or any other flammable materials in this product. Use only household detergents, cleaners and degreasers recommended for use in washer pump. Wear protective clothing to protect eyes and skin from contact with sprayed materials.

Hazard	
DANGER RISK OF UNSAFE OPERATION 	
WHAT CAN HAPPEN	HOW TO PREVENT IT
<ul style="list-style-type: none"> ● Unsafe operation of your washer pump could lead to serious injury or death to you or others. 	<ul style="list-style-type: none"> ● Do not use chlorine bleach or any other corrosive compound. ● Become familiar with the operation and controls of the washer pump. ● Keep operating area clear of all persons, pets and obstacles. ● Do not operate the product when fatigued or under the influence of alcohol or drugs. Stay alert at all times. ● Never defeat the safety features of this product. ● Do not operate machine with missing, broken, or unauthorized parts. ● Never leave lance unattended while unit is running.
<ul style="list-style-type: none"> ● If proper starting procedure is not followed, engine can kickback , causing serious hand and arm injury. 	<ul style="list-style-type: none"> ● If engine does not start after two pulls, squeeze trigger of gun to relieve pump pressure, pull starter cord slowly until resistance is felt. Then pull cord rapidly to avoid kickback and prevent hand or arm injury.
<ul style="list-style-type: none"> ● The gun/lance is a powerful cleaning tool that could look like a toy to a child. 	<ul style="list-style-type: none"> ● Keep children away from the washer pump at all times.
<ul style="list-style-type: none"> ● Reactive force of spray will cause gun/wand to move, and could cause the operator to slip or fall, or misdirect the spray. Improper control of gun/ lance can result in injury to self and others. 	<ul style="list-style-type: none"> ● Do not overreach or stand on an unstable support. Grip gun/lance firmly with both hands. Expect the gun to kick when triggered.

Hazard	
DANGER RISK OF ELECTRICAL SHOCK 	
WHAT CAN HAPPEN	HOW TO PREVENT IT
<ul style="list-style-type: none"> ● Spray directed at electrical outlets or switches. or objects connected to an electrical circuit, could result in a fatal electrical shock. 	<ul style="list-style-type: none"> ● Unplug any electrically operated product before attempting to clean it. Direct spray away from electric outlets and switches.

SAFETY SYMBOL	INSTRUCTION
	This manual must be read before beginning installation of the unit.
	High pressure water jets are potentially dangerous if used incorrectly. In particular, do not direct the water jet towards people or animals, electrical equipment or the unit itself.

CARTON CONTENTS

Note: photographs and line drawings used in this manual are for reference only and do not represent a specific model.

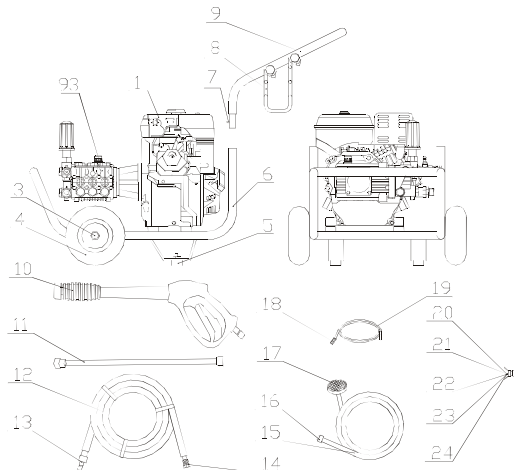

No.	Description	Qty
1	Engine	1
2	Pump	1
3	Wheel	1
4	Hub Cap	1
5	Rubber Foot	2
6	Carrier	1
7	Pin	2
8	Vinyl Round Cap	1
9	Handle	1
10	Gun Assy.	1
11	Assy. Wand & Quick Connect	1
12	High Pressure Water Hose	1
13	Plated Steel Quick Connect 3/8	1
14	Brass Quick Connect 3/8	1
15	Inlet Hose	1
16	Inlet Hose Adaptor	1
17	Filter	1
18	Chemical Filter	1
19	Chemical Hose	1
20	Nozzle Black	1
21	Nozzle White	1
22	Nozzle Green	1
23	Nozzle Yellow	1
24	Nozzle Red	1

SPECIFICATIONS

Model	15G27-7A	15G36-13A
Max. Pressure (PSI / bar)	2700/186	3600/248
Flow (GPM / L/min)	3.8/14.4	4.76/18
R.P.M.	3400	3400
Power	7HP	13HP
Displacement (cc)	210	389
Fuel capacity (L)	3.6	6.5

ASSEMBLY INSTRUCTIONS

1. Place handle assembly onto frame.

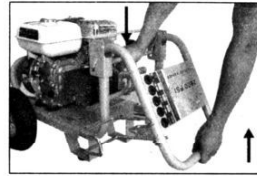
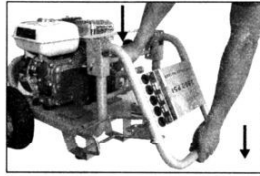

2. Attach high pressure water hose to gun. Tighten securely.



3. Connect lance to gun. Tighten securely.



4. Assemble grommet kit and quick-connect nozzles as described in the instructions supplied.

5. Add engine oil to engine. Refer to engine owners manual supplied by engine manufacturer for correct procedure.

NOTE There will be a slight amount of oil in the engine from factory testing.

6. Install oil inlet plug into pump, tighten securely.
Check oil drain plug into pump, tighten securely.

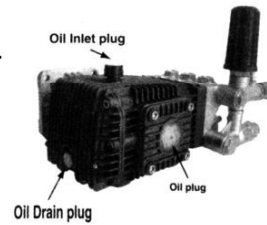

OPERATING INSTRUCTIONS

READ THIS OWNER'S MANUAL AND SAFETY RULES BEFORE OPERATING YOUR UNIT. Compare the illustrations with your unit to familiarize yourself with the location of various controls and adjustments. Save this manual for future reference.

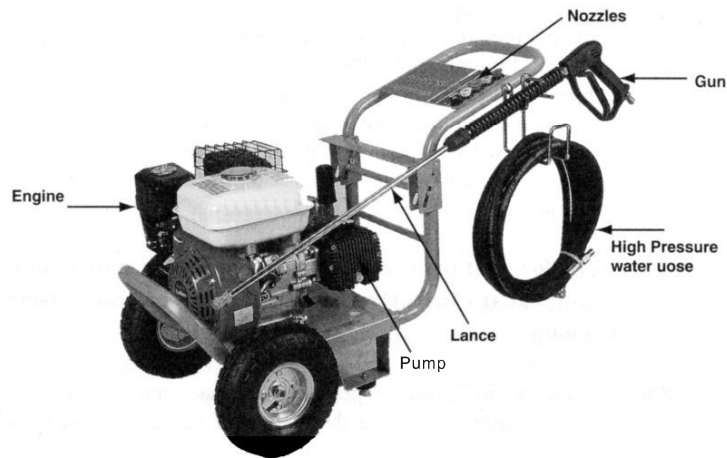

BASIC ELEMENTS OF A WASHER PUMP

Washer Pump: Increases the pressure of the water supply.

Engine: Drives the washer pump.

High Pressure Water Hose: Carries the pressurized water from the pump to the gun and lance.

Gun: Connects with lance to control water flow rate, direction, and pressure.

Lance: Lance is equipped with a female quick fix-up on the end. This allows the user to quickly change out nozzle for different spray patterns and change the soap nozzle for the low pressure and chemical /soap applications .see how to use lance paragraph in this section.

Chemical Hose: Feeds cleaning agents into the pump to mix the pressurized water. see how to apply chemical /cleaning solvent in this section of this manual.

BASIC ELEMENTS OF ENGINE

Refer to the engine manual for location and operation of engine controls.

Choke Control Lever: Controls engine speed.

Starter Grip: Pulling starter grip operates recoil starter to crank engine.

Fuel Valve Lever: Opens\Closes connection between fuel tank and carburetor.

Engine Switch: Enables and disables ignition system.

WASHER PUMP TERMINOLOGY

PSI: Pounds per square inch. the unit of measure for water pressure. also used for air pressure, hydraulic pressure ,etc.

LPM: Litre per minute, the unit of measure for the flow rate of water

Bypass Mode: In bypass mode, the pump is recirculating water because the trigger of the spray gun is not pulled. If unit is left in bypass mode for more than two (2) minutes, the water temperature will rise to a dangerous level and could damage internal components of the pump. Any damage to pump due to these causes will not be covered under warranty.

! CAUTION Do not allow unit to operate in bypass mode for more than two minutes at any time. Overheating of pump can cause damage to pump.

Thermal Relief Valve: In an effort to prevent extreme damage pumps are equipped with a thermal relief valve. This valve will open when the temperature inside the pump rises too high. This valve will then release a gush of water in an effort to lower the temperature inside the pump. Immediately after this occurs, the valve will close.

Chemical Injection System: Mixes soap or cleaning agents with the pressurized water to improve cleaning effectiveness.

Water Supply: All pressure washers must have a source of water. the minimum requirements for a water supply are 20 PSI and 19 Litre per minute.

WASHER PUMP OPERATING FEATURES

PRESSURE REGULATOR

The pressure setting is preset at the factory to achieve optimum pressure and cleaning .if you need to lower the pressure, it can be accomplished by these methods

1. Back away from the surface to be cleaned .The further away you are, the less the pressure will be on the surface to be cleaned

! CAUTION Do not attempt to increase pump pressure. A higher pressure setting than the factory set pressure may damage pump.

2. **Reduce the speed of the engine (RPM).** Slow the engine down and the water pressure will go down with it.
3. **Change to the 40° white nozzle,** This nozzle delivers a less powerful stream of water and a wider spray pattern.
4. **Adjust the pressure regulator on the pump.** Turn the pressure regulator knob counter-clockwise to lower pressure. once you have finished using your pressure washer, return the pressure regulator to its original position by turning it clockwise.

! CAUTION Do not try to turn pressure regulator knob past the built-in stop or damage to pump will result

TO USE LANCE

Your washer pump is equipped with up to four spray nozzles. Each nozzle is colors coded. and delivers a specific spray pattern for a particular cleaning purpose. The size of the nozzle determines the size of the fan spray and the pressure out of the nozzle. The 0°, 15°, and 40° nozzles are high pressure nozzles, the chemical nozzle 84° is a low pressure nozzle.

The nozzles are housed in receptacles on the panel of the washer pump handle. Colors on the panel identify nozzle location and spray pattern.

!WARNING Risk of injection or injury to person. Do not direct discharge stream toward persons, unprotect skin, eyes, or any pets or any animals. Serious injury can occur.

CHANGING NOZZLES

!CAUTION DO NOT attempt to change nozzles while washer pump is running. Turn engine or gun off before changing nozzles.

1. Pull quick fix-up back and insert nozzle.
2. Release quick fix-up and twist nozzle to make sure it is secure in quick fix-up socket.

!WARNING Risk of injury. Ensure nozzle is completely inserted in quick fix-up socket before squeezing gun trigger

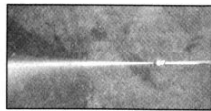

0° nozzle-red. This nozzle delivers a pinpoint stream and is extremely powerful. It covers a very small area of cleaning. This nozzle should only be used on surface that can withstand this high pressure such as metal or concrete. Do not use on wood.



15° nozzle-yellow. This nozzle delivers a powerful 15 degree spray pattern for intense cleaning of small areas. This nozzle should only be used on areas that can withstand the high pressure from this nozzle.



25° nozzle-green. This nozzle delivers a 25 degree spray pattern for intense cleaning of larger areas. This nozzle should only be used on areas that can withstand the pressure from this nozzle.



40° nozzle-white. This nozzle delivers a 40 degree spray pattern and a less powerful stream of water. It covers a wide area of cleaning, this nozzle should be used for most general cleaning jobs.

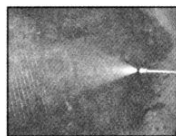

Chemical nozzle-black. This nozzle is used to apply chemicals or cleaning solutions. It has the least power stream.

HOW TO APPLY CHEMICALS AND CLEANING SOLVENTS

!WARNING Applying chemicals or cleaning solvents is a low pressure operation.

!NOTE Use only soaps and chemicals designed for washer pump use. **Do not use bleach.**

To apply chemicals:

1. Press chemical hose onto barbed fitting located near high pressure water hose connection of pump as shown.

2. Place other end of chemical hose with filter on it into container holding chemical/cleaning solution.

!NOTE The chemical/water ratio is 1:7, for every 7 litres of water pumped, 1 litre of chemical/cleaning solution will be used.

3. Install low pressure (black) nozzle into quick fix-up of lance, see How To Use Lance paragraph in this section.

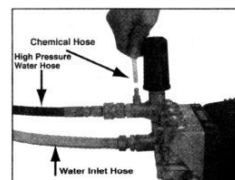

4. After use of chemicals, place chemical hose into container of clean water and draw clean water through chemical injection system to rinse system thoroughly. If chemicals remain in the pump it could be damaged. Pumps damaged due to chemicals will not be covered under warranty.

[NOTE] Chemicals and soaps will not siphon when lance is in the high pressure setting.

READ AND UNDERSTAND ALL WARNINGS BEFORE STARTING UNIT

[DANGER] **When using the high pressure setting, DO NOT** allow the high pressure spray to come in contact with unprotected skin, eyes, or with any pets or animals. Serious injury can occur.

Your washer operates at fluid pressures and velocities high enough to penetrate human and animal flesh, which could result in amputation or other serious injury. Leaks caused by loose fittings or worn or damaged hoses can result in injection injuries. **DO NOT TREAT FLUID INJECTION AS A SIMPLE CUT! See a physician immediately!**

[WARNING] **NEVER** fill fuel tank when engine is running or hot. Do not smoke when filling fuel tank.

NEVER fill fuel tank completely. Fill tank to 10mm below bottom of filler neck to provide space for fuel expansion. Wipe any fuel spillage from engine and equipment before starting engine.

NEVER run engine indoors or in enclosed, poorly ventilated areas. Engine exhaust contains carbon monoxide, an odorless and deadly gas.

DO NOT let hoses come in contact with very hot engine muffler during or immediately after use of your washer pump. Damage to hoses from contact with hot engine surfaces will NOT be covered by warranty.

[CAUTION] **NEVER** pull water supply hose to move washer pump. This could damage hose and pump inlet.

DO NOT use hot water, use cold water only.

NEVER turn water supply off while washer pump engine is running or damage to pump will result.

DO NOT stop spraying water for more than two minutes at a time. Pump operates in bypass mode when spray gun trigger is not pressed. If pump is left in bypass mode for more than two minutes internal components of the pump can be damaged.

STARTING

Prior to starting, refer to your engine manual for proper starting procedures for your engine type.

1. **In a well ventilated outdoor area** add fresh, high quality, unleaded **petrol** with a pump octane rating of 86 or higher. Do not overfill. Wipe up spilled fuel before starting the engine. Refer to Engine Owners Manual for correct procedure.
2. **Check engine oil level.** See Engine Owners Manual for correct procedure.
INOTE There will be a slight amount of oil in the engine from factory testing.
3. **Verify the filter screen** is in water inlet of pump.
INOTE Cone side faces out.
4. **Connect** water source to pump inlet.
INOTE Water source must provide a minimum of 19 litres per minute at 20 PSI.
5. **Connect** high pressure water hose to pump outlet.
6. **If applying a chemical or cleaning solution,** see How To Apply Chemicals/Cleaning Solvents in Operation section of this manual.
7. **Turn water source on.**
INOTE Failure to do so could cause damage to the pump.
8. **Start engine.** See Engine Owners Manual for correct procedure.
INOTE If the engine does not start after two pulls, pull the trigger on gun to relieve the pressure.
9. **Depress trigger on gun to start water flow.**
INOTE Stand on a stable surface and grip gun with both hands. Expect the gun to kick when triggered.
10. **Release trigger to stop water flow.**
11. **Adjust spray for the task** being performed by changing quick fix-up nozzle. See How To Use Lance instructions in this section.

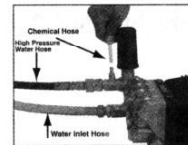
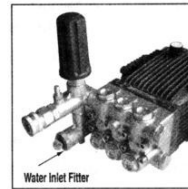

SHUTTING DOWN

1. **After each use,** if you have applied chemicals, place chemical hose into container of clean water and draw clean water through chemical injection system to rinse system thoroughly.
INOTE Failure to do so could cause damage to the pump.
2. **Turn engine off.** See engine owner's manual.
INOTE NEVER turn the water off with the engine running.
3. **Turn water source off.**
4. **Pull trigger on spray gun** to relieve any water pressure in hose or gun.
5. **See storage section** in this manual for proper storage procedures.

MAINTENANCE

!WARNING When performing maintenance, you may be exposed to hot surfaces, water pressure, or moving parts that can cause serious injury or death!

Before performing any maintenance or repair, disconnect spark plug wire, let engine cool and release all water pressure. The engine contains flammable fuel. **DO NOT** smoke or work near open flames while performing maintenance.

To ensure efficient operation and longer life of your washer pump, a routine maintenance schedule should be prepared and followed. If the washer pump is used in unusual conditions, such as high-temperature or dusty conditions, more frequent maintenance checks will be required

ENGINE

Consult the Engine Owners Manual for the manufacturer's recommendations for any and all maintenance.

CHANGING OIL INLET PLUG

▲ CAUTION The red plug on the pump is specially designed for transportation, before using the unit, please replace the red plug with the yellow plug or the brass plug in the spare parts package.

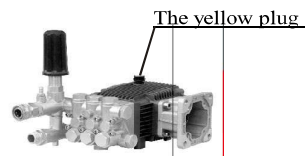
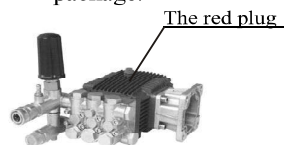

TO CHECK OIL

1. Remove oil inlet plug from pump and wipe clean.
2. Insert oil inlet plug fully into pump, then remove it.
3. Oil level is correct when oil covers the lower 1/2 inch of end of oil inlet plug.

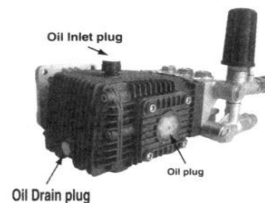

HOW TO CHANGE PUMP OIL

1. Loosen oil inlet plug.
2. Place a container under the oil drain plug.
3. Remove oil drain plug.
4. After oil is drained replace oil drain plug .tighten securely.
5. Remove oil inlet plug and fill with recommended oil, see the pump oil chart for the correct amount and type of oil.
6. Replace oil inlet plug and tighten securely.

Oil type: SAE 15W-40 or equivalent motor oil.

Type	15G27-7A/15G36-13A
Oil capacity (ml)	480±5

SPRAY WAND

If the nozzle becomes clogged with foreign materials such as dirt, excessive pressure may develop. If the nozzle becomes partially clogged or restricted, the pump pressure will pulsate. Clean the nozzle immediately using the nozzle kit supplied and the following instructions:

1. Shut off the washer pump and turn off the water supply.
2. Pull trigger on gun to relieve any water pressure.
3. Disconnect the lance from the gun.
4. Remove the nozzle from the lance. Remove any obstructions with the nozzle cleaning tool provided and backflush with clean water.
5. Direct water supply into spray wand end to backflush loosened particles for 30 seconds.



6. Reassemble the nozzle to the lance.
7. Reconnect lance to gun and turn on water supply.
8. Start washer pump and place lance into high pressure setting to test.

HOW TO CLEAN THE WATER INLET FILTER

This screen filter should be checked periodically and cleaned if necessary.

1. **Remove filter** by grasping end and removing it from water inlet of pump as shown.
2. **Clean filter** by flushing it with water on both sides.
3. **Re-insert filter** into water inlet of pump.

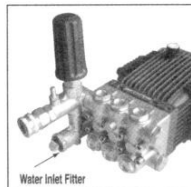

NOTE Cone side faces out.

NOTE Do not operate pressure washer without filter properly installed.

STORAGE

ENGINE

Consult the owners manual for the manufacturer's recommendations for storage.

PUMP

1. **Drain all water from high pressure water hose**, coil it, and store it in cradle of the washer pump handle.
2. **Drain all water from gun and lance** by holding gun in a vertical position with nozzle end pointing down and squeezing trigger. Store in gun/hose holder.
3. **Store chemical hose**, high pressure water hose, so they are protected from damage, such as being run over.

It is recommended that you follow these steps to protect the internal seals of the washer pump when **STORING THE UNIT FOR MORE THAN 30 DAYS AND/OR WHEN FREEZING TEMPERATURES ARE EXPECTED.**

4. **Obtain a funnel**, 1 litre of antifreeze, and approximately 1 metre of garden hose with a male hose connector attached to one end.
5. **Disconnect spark plug wire.**
6. **Connect 1 metre length of hose** to water inlet of pump.
7. **Add antifreeze** to hose.
8. **Pull engine starter rope slowly several times**, until antifreeze comes out of high pressure water hose connection of pump.
9. **Remove short hose** from water inlet of pump.
10. **Reconnect spark plug wire.**

PUMP DIAGRAM

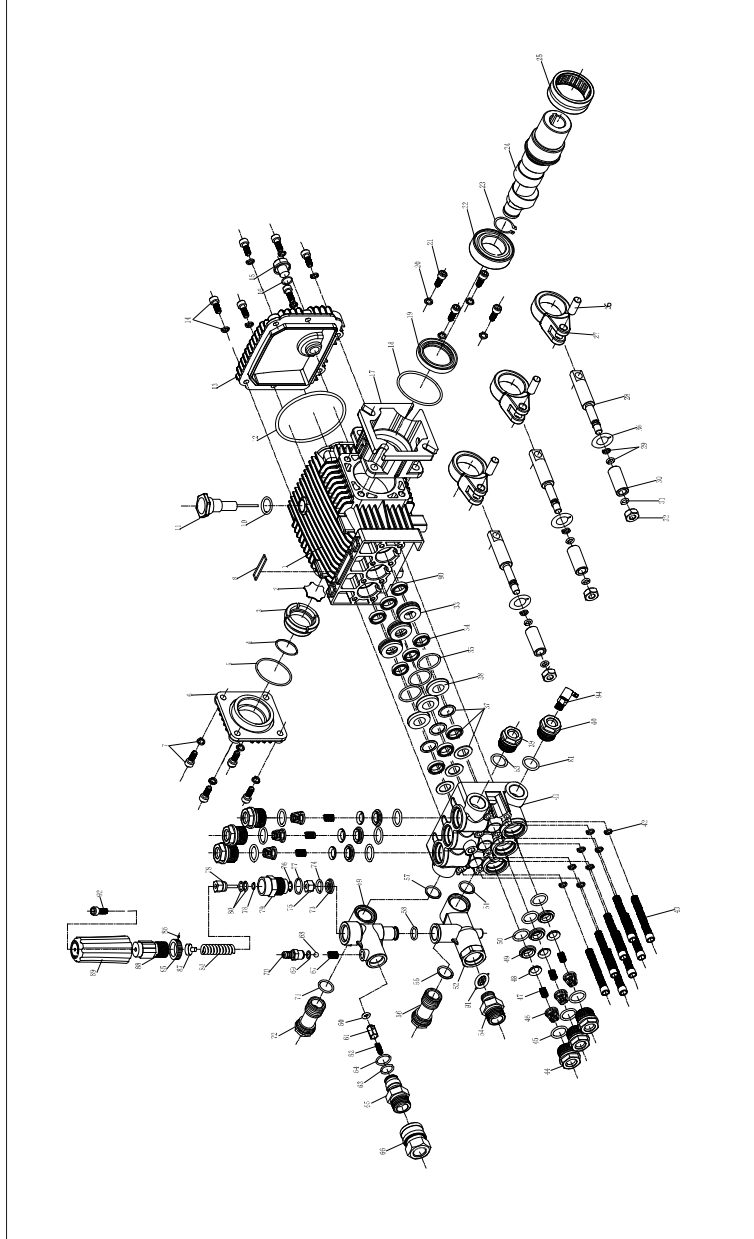

No.	Description	Qty	No.	Description	Qty	No.	Description	Qty	No.	Description	Qty
1	Crank Case	1	33	Compressor Ring	3	65	Adaptor	1			
2	Oil Gauge Plate	1	34	Compressor Water Seal	3	66	Outlet QC Connector	1			
3	Oil Gauge	1	35	O Ring	3	67	Spring	1			
4	O Ring, Oil Gauge	1	36	Check Ring	3	68	Ball	1			
5	O Ring	1	37	Water Seale	3	69	O Ring	1			
6	Cover, Crankshaft	1	38	Backup Ring	3	70	Soap Suction Nozzle	1			
7	Screw & Gasket	4	39	G3/4 Outlet Plug	1	71	O Ring	1			
8	Brand 1	1	40	G1/2 Inlet Plug	1	72	Outlet Connection	1			
9	Brand 2	2	41	Manifold Head	1	73	Seat	1			
10	O Ring	1	42	Washer	8	74	O Ring	1			
11	Oil Plug	1	43	Bolt	8	75	Bullet	1			
12	O Ring	1	44	Valve Cage	6	76	O Ring	1			
13	Crank Case Cover	1	45	O Ring	6	77	O Ring	1			
14	Screw & Gasket	4	46	Valve Cage	6	78	O Ring	1			
15	Drain Plug	1	47	Spring	6	79	Valve Body	1			
16	O Ring, Drain Plug	1	48	Valve Plate	6	80	O Ring	1			
17	Flangc	1	49	Seat	6	81	B Ring	1			
18	O Ring, Flange	1	50	O Ring	6	82	Adjusting Spindle.	1			
19	Oil Seal, Crankshaft	1	51	O Ring	1	83	Spring Seat (down)	1			
20	Washer	4	52	Inlet T Connection	1	84	Spring Seal	1			
21	Screw	4	53	O Ring	1	85	Jam Nut	1			
22	Bearing	1	54	Adaptor	1	86	Fix Screw	1			
23	Clip	1	55	O Ring	1	87	Spring Seal (up)	1			
24	Crankshaft	1	56	Inlet Banjo Bolt	1	88	Knob	1			
25	Needle Bearing	1	57	O Ring	1	89	Plastic Cap, knob	1			
26	Plunger Pin	3	58	O Ring	1	90	Oil Seal Plunger	1			
27	Connecting Rod	3	59	Outlet T Connection	1	91	Filter Net	1			
28	Plunger Guide	3	60	O Ring	1	92	Screw	1			
29	Backup Ring	3	61	Spindle	1	93	Pump Assembly	1			
30	Ceramic Pipe	3	62	Spring	1	94	Thermal Protect Valve Assy.	1			
31	Plunger Washer	3	63	O Ring	1						
32	Fix Nut	3	64	O Ring	1						

TROUBLE SHOOTING GUIDE

PROBLEM	CAUSE	CORRECTION
Engine will not start (see Engine Manual for further engine troubleshooting)	No fuel.	Add fuel.
	Low oil.	Add required amount of oil.
	Pressure builds up after two pulls on the recoil starter or after initial use.	Squeeze gun trigger to relieve pressure.
	Choke lever in the "no choke" position.	Move choke to the "choke" position.
	Spark plug wire not attached.	Attach spark plug wire.
	Engine ON/OFF switch in OFF position.	Place engine ON/OFF switch in ON position.
	Choke lever in the "choke" position on a "hot" engine or an engine that has been exposed to thermal heat for a long period of time.	Move choke to the "NO CHOKE" position.
Fuel valve closed.	Move fuel valve lever to the "open" position.	
No or low pressure (initial use)	Lance not in high pressure.	See how to use lance paragraph in the operation section.
	Lower water supply.	Water supply must be at least 19 LPM.
	Leak at high pressure water hose fitting.	Tighten. Apply sealant tape if necessary.
	Nozzle obstructed.	See lance paragraph in the maintenance section for the correct procedure.
	Water filter screen clogged.	Remove and clean filter.
	Air in hose.	Turn off the engine, then the water source. Disconnect the water source from the pump inlet and turn the water source on to remove all air from the hose. When there is a steady stream of water present, turn water source off. Re-connect water source to pump inlet and turn on water source. Squeeze trigger to remove remaining air.

PROBLEM	CAUSE	CORRECTION
No or low pressure (initial use)	Choke lever in the "choke" position.	Move choke to the "No choke" position.
	Throttle control lever is not in the "Fast" position.	Move throttle control lever to the "fast" position.
	High pressure water hose is too long.	Use high pressure water hose under 15 metres.
Will not draw chemicals	Lance not in low pressure.	See How To Use Lance paragraph in the operation section.
	Chemical filter clogged.	Clean filter.
	Chemical screen not in chemical.	Ensure end of chemical hose is fully submerged into chemical.
	Chemical too thick.	Dilute chemical. Chemical should be the same consistency as water.
	Pressure hose is too long.	Lengthen water supply hose instead of high pressure water hose.
	Chemical build up in chemical injector.	Have parts cleaned or replaced.
No or low pressure (after period of normal use)	Worn seal or packing.	Check and replace.
	Worn or obstructed valves.	Check and replace.
	Worn unloader piston.	Check and replace.
Water leaking at gun/lance connection	Worn or broken o-ring.	Check and replace.
	Loose hose connection.	Tighten.
Oil leaking at pump	Oil seals worn.	Check and replace.
	Loose oil drain plug.	Tighten.
	Worn oil drain plug o-ring.	Check and replace.
	Worn fill plug o-ring.	Check and replace.
	Pump overfilled.	Check for correct amount.
	Incorrect oil used.	Drain and fill with correct amount and type of oil.
	Vent plug is clogged.	Clean vent plug; blow air through it to remove any blockage. If problem persists, replace plug.
Pump pulsates	Nozzle obstructed.	See Lance paragraph in the maintenance section for the correct procedure.

QUICK FACTS

TO FIND A LOCAL AUTHORIZED SERVICE CENTER NEAR YOU FOR REPAIRS AND SERVICE PART PURCHASES.

PETROL	Use fresh high quality unleaded petrol. Add stabilizer to fuel tank and run engine for 5 minutes before storage.
OIL	Pump oil: refer to owners manual supplied with this unit. Engine oil: refer to engine manual supplied with his unit. Some units are equipped with a low oil sensor and adequate oil must be added or the unit will not start.
WATER	Use only cold water. Do not operate unit with clogged or missing water filter /screen. Do not operate unit without adequate water supply to pump. Adequate water supply is a minimum of 20 PSI and 19 LPM.
PRESSURE ADJUSTMENT	The pressure setting is preset at the factory to achieve optimum cleaning. If you need to lower the pressure setting, refer to the operation manual for proper procedure.
PUMP	Pull gun trigger every 2 minutes while engine is running. Do not allow water to freeze in pump. For cold weather or long term storage refer to the operation manual for proper procedure.
BY-PASS MODE	Never leave unit running for more than 2 minutes without pulling gun trigger, doing so could cause damage to pump and void warranty.
HOSE	Do not allow hoses to contact the hot engine muffler during or after use. Never pull the hose to move the unit.
ENGINE	Do not adjust or attempt maintenance without consulting engine manual or an authorized engine service center. Add stabilizer to fuel tank and run engine for 5 minutes before storage. Always turn on the water before starting the engine.
CHEMICALS/ SOAP	Use only soaps and chemicals designed for washer puma use.
NOZZLE	Keep nozzle unclogged. Refer to manual for cleaning procedures. Chemicals/soap cannot be applied in high pressure setting. Only in low setting.
MAINTENANCE SCHEDULE	Follow recommended maintenance schedule for engine & pump. Refer to manuals.
STORAGE OR WINTERIZING	Draw clean water through chemical inlet. Add stabilizer to fuel tank and run engine for 5 minutes before storage. Do not allow water to freeze in pump, gun, lance or hoses. For cold weather or long term storage refer to the operation manual for proper procedure.

ALWAYS REFER TO THE MANUALS SUPPLIED WITH THIS UNIT

DISPOSAL OF THE MACHINE

- If you decide not to use the machine anymore, it is recommended to remove the power supply cord.
- In any case it must be kept out of the reach of children.
- Being as the machine is a special waste, disassemble it and gather the homogeneous parts for disposal according to the applicable laws.
- Do not use the scrapped parts as spare parts.

ENVIRONMENTAL PROTECTION



Please arrange for the proper disposal of the packaging.

The packaging material can be recycled.

Please do not place the packaging into the ordinary refuse for disposal, but arrange for the proper recycling.



Please arrange for the proper disposal of the old appliance.

Old appliances contain valuable materials that can be recycled.

Please arrange for the proper recycling of old appliances. Batteries, oil, and similar substances must not enter the environment. Please dispose of your old appliances using appropriate collection systems.